

# INSTRUCTION MANUAL

## Orion® StarBlast™

#9814 4.5" Altazimuth Reflector Tabletop Telescope



 **ORION®**  
**TELESCOPES & BINOCULARS**  
*Providing Exceptional Consumer Optical Products Since 1975*

**Customer Support (800)-676-1343**  
**E-mail: [support@telescope.com](mailto:support@telescope.com)**  
**Corporate Offices (831)-763-7000**  
**89 Hangar Way, Watsonville, CA 95076**

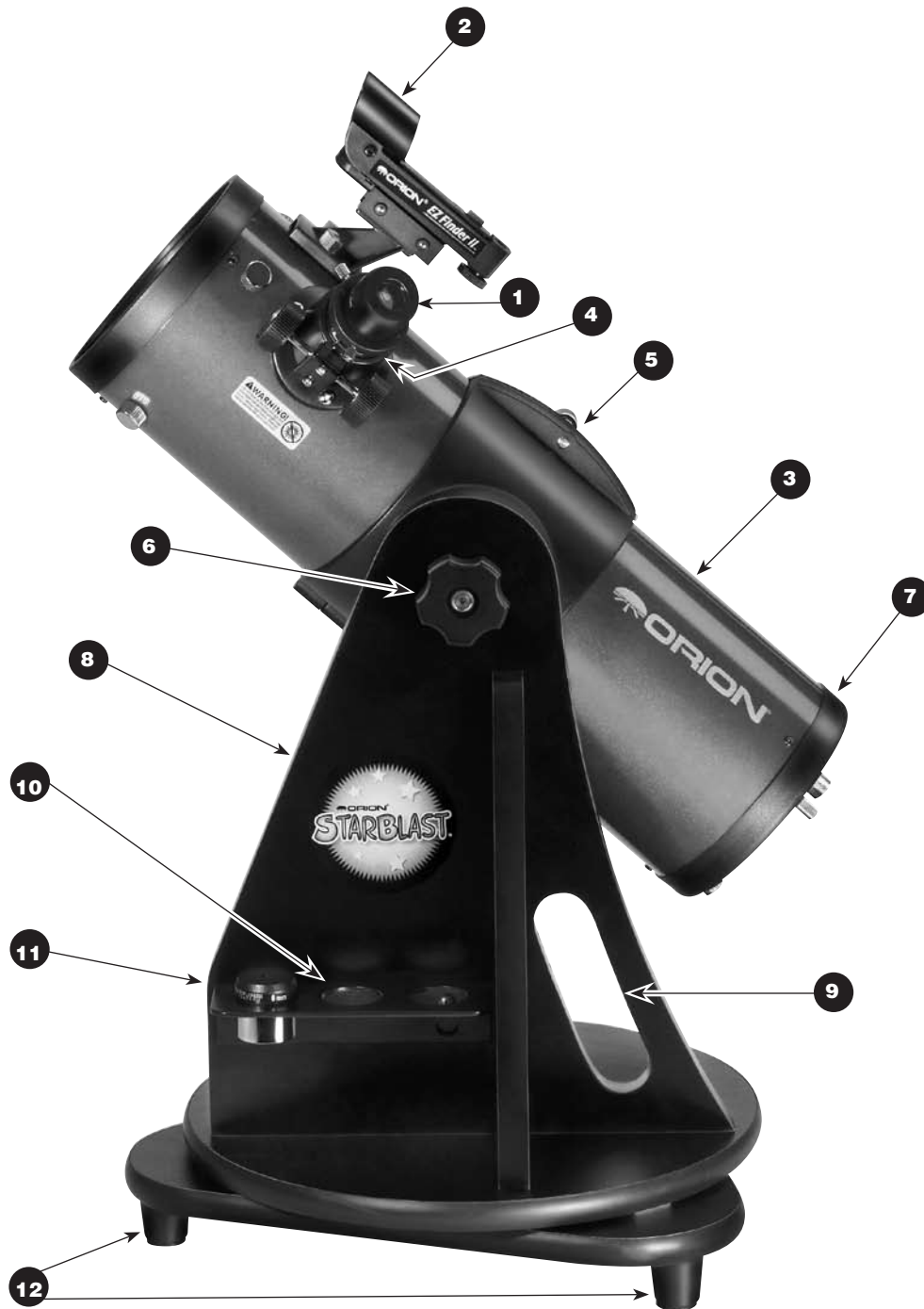

**Figure 1.** The StarBlast.

*Congratulations on your purchase of an Orion StarBlast telescope. Your new StarBlast is easy to use and requires very little assembly. The StarBlast will give you breathtaking views of the Moon, planets, and even deep sky objects like the Orion Nebula. These instructions will help you set up and use your StarBlast telescope, please read them thoroughly.*

## StarBlast parts:

### 1 17mm Explorer II eyepiece

The eyepiece is the part of the telescope that you actually look through to see things. The focal length of the eyepiece and the telescope determines the magnifying power. Magnification is discussed in more detail in the Using Your Telescope section.

### 2 EZ Finder II reflex sight

This is a special “finder” that helps you aim the telescope and locate objects in the sky for viewing. The EZ Finder II generates a red LED “dot” that shows where your telescope is aimed. The use of the EZ Finder II is discussed in the Getting Started section.

### 3 Optical tube

This is the main component of the telescope.

### 4 Focuser

This is where the eyepiece is placed, and it is where you focus. Details of the focuser are shown in Figure 2.

### 5 Tube clamp

This clamp connects the optical tube to the wood base.

### 6 Altitude tension adjustment knob

By tightening or loosening this knob, you can change the amount tension in the altitude (up/down) motion of the telescope.

### 7 Mirror cell

This contains the **primary mirror** as well as the collimation thumbscrews that are used to optically align the primary mirror. This is explained in Appendix A: Aligning the Mirrors.

### 8 Altazimuth base

This wooden base provides a stable mount for the telescope. It allows you to move the telescope in altitude (up/down) and azimuth (left/right).

### 9 Carrying handle

This convenient handle built into the base allows you to easily carry the StarBlast to your viewing location. The carrying handle is also a handy place to put your other hand when aiming the telescope. See Using Your Telescope for more details.

### 10 Eyepiece rack

A handy metal rack in which to store your extra eyepieces.

### 11 6mm Explorer II eyepiece

The higher-power eyepiece that comes with the StarBlast Eyepieces are discussed in the **Magnification** section.

### 12 Rubber feet

Three feet provide support for the StarBlast and are skid free. This allows you to place the StarBlast on smooth surfaces.

Figure 2 shows detail of the focuser

### 13 Focus Wheels

The focus wheels are used to bring objects into focus. By turning them, you move the rack-and-pinion **focuser (4)** in and out.

### 14 Eyepiece securing thumbscrews

These thumbscrews are used to keep the **eyepiece (1)** secure in the **focuser (4)**.

Items not shown

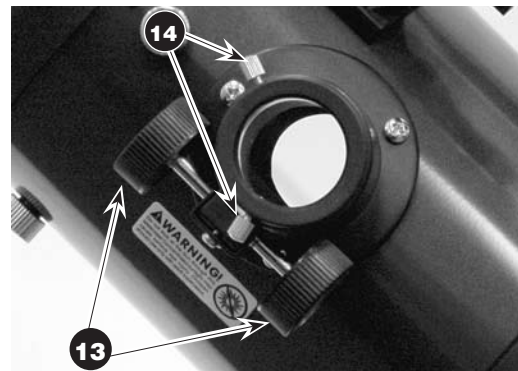

**Figure 2.**  
Details of the focuser.

### 15 Primary Mirror

The parabolic mirror at the rear of the **optical tube (3)** gathers incoming light and focuses it with its parabolic shape. The primary mirror has a small center-mark that is explained in Appendix A. This center-mark should not be removed.

### 16 Secondary Mirror

The secondary mirror is located near the opening of the **optical tube (3)** and reflects the focused light from the **primary mirror** into the **eyepiece (1)**.

### 17 Collimation cap

This small cap fits in the focuser and is used to aid in aligning of the optics. This process is explained in Appendix A.

# Table of Contents

Assembly . . . . .	4
Getting Started . . . . .	4
Using Your Telescope . . . . .	6
Care and Maintenance . . . . .	9
Specifications . . . . .	9
Appendix A: Aligning the Mirrors. . . . .	9
Appendix B: Cleaning the Optics. . . . .	11

**WARNING:** *Never look directly at the Sun through your telescope or its finder scope—even for an instant—without a professionally made solar filter that completely covers the front of the instrument, or permanent eye damage could result. Young children should use this telescope only with adult supervision.*

## Assembly

Assembly of the StarBlast is very easy. You just remove it from its packaging, place the telescope on a table or other flat surface and locate the following accessories:

- 1 EZ Finder II reflex sight (2)
- 1 17mm Explorer II eyepiece (1)
- 1 6mm Explorer II eyepiece (11)

### Attaching the EZ Finder II

Remove the two metal thumbnuts from the optical tube (Figure 3). Place the bracket of the **EZ Finder II (2)** on the tube so that the holes in the bracket slide over the two threaded posts on the tube. The EZ Finder should be oriented so that it appears as in Figure 1. Thread the thumbnuts back onto the posts to secure the EZ Finder II in place.

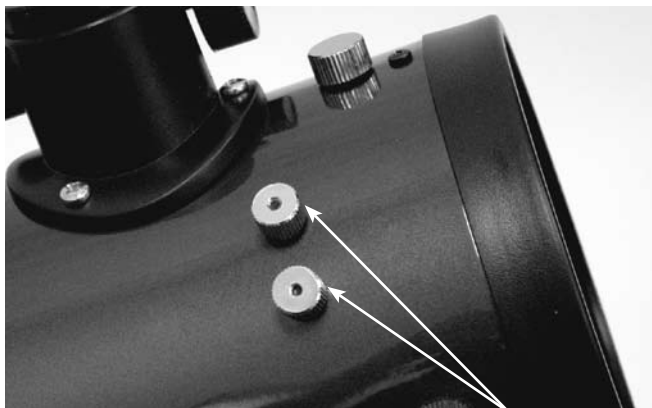

**Figure 3.** The EZ Finder II securing thumbnuts.

### Inserting the Eyepiece

Loosen the **eyepiece securing thumbscrews (14)**. Insert the chrome barrel of the **17mm Explorer II eyepiece (1)** into the **focuser (4)** and secure it with the thumbscrews. You can place the **6mm Explorer II eyepiece (11)** in the **eyepiece rack (10)** for use later.

Your telescope is now fully assembled and should resemble Figure 1. Remove the dust cap from the front of the telescope when it is in use. Replace it when you are finished observing.

## Getting Started

It's best to get a feel for the basic functions of the StarBlast during the day, before observing astronomical objects at night. This way you won't have to orient yourself in the dark! Find a spot outdoors where you'll have plenty of room to move the telescope, and where you'll have a clear view of some object or vista that is at least 1/4 mile away. It is not critical that the telescope be exactly level, but it should be placed on something relatively flat to ensure smooth movement.

The StarBlast was designed specifically for visual observation of astronomical objects in the night sky. Like all Newtonian reflector telescopes, it is not well suited for daytime terrestrial usage because the image in the eyepiece is inverted (upside-down).

### Placing the StarBlast

One of the great assets of the StarBlast is its extremely portable size. Due to its overall short height, you will find that viewing while sitting down on the ground next to the telescope is the most comfortable. If you wish to raise the telescope off the ground so that it can be used while standing or sitting in a chair, then a platform, such as a milk crate or table, can be used.

### Altitude and Azimuth (Aiming the Telescope)

The StarBlast **altazimuth base (5)** permits motion along two axes: altitude (up/down) and azimuth (left/right). See Figure 4. Moving the telescope up/down and right/left is the "natural" way people aim objects which makes pointing the telescope intuitive and easy.

Simply take hold of the telescope tube (Figure 5) and move it left or right so that the base rotates. Move it up or down in the same manner. Both motions can be made simultaneously and in a continuous manner for easy aiming. This way you can point to any position in the night sky, from horizon to horizon.

You may find it convenient to hold one hand near the **carrying handle (9)** to steady it while moving and aiming the telescope.

If you find that it is too hard to put your eye up to the **eyepiece (1)**, you can rotate the tube by loosening the knob on the **tube clamp (5)** and rotating the **optical tube (3)** until the **focuser (4)** is in a convenient position.

When aiming the telescope in altitude, you may find that the **optical tube (3)** is either too hard to move or does not stay in place. Use the **altitude adjustment tension knob (6)** to change the amount of tension between the **tube clamp (5)** and the **alt-azimuth base (8)** to find the right level of tension to properly move and balance the telescope.

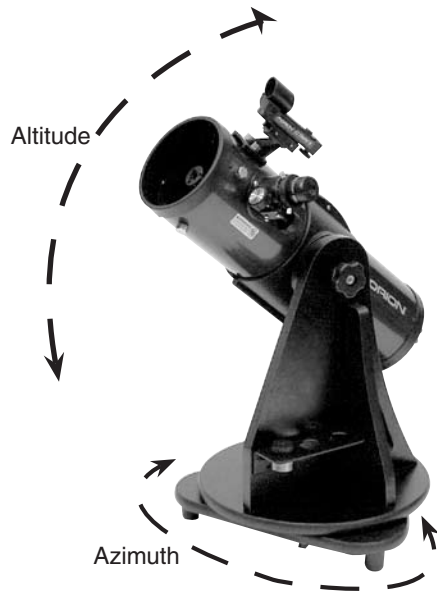

**Figure 4.** The StarBlast has two axes of motion: altitude (up/down) and azimuth (left/right).

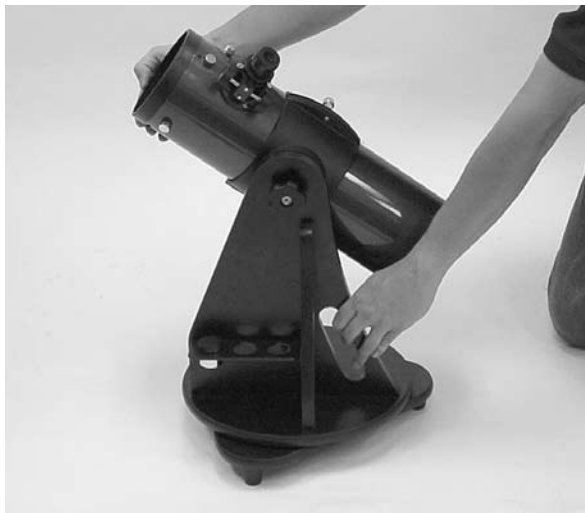

**Figure 5.** Try grasping the telescope as shown for easiest pointing. One hand moves the telescope from the front of the tube while the other hand remains on the handle to keep the telescope steady.

### Focusing the Telescope

With the **17mm Kellner eyepiece (1)** inserted into the **focuser (4)** and secured with the thumbscrews, aim the **optical tube (3)** so the front (open) end is pointing in the general direction of an object at least 1/4-mile away. With your fingers, slowly rotate one of the **focus wheels (15)** until the object comes into sharp focus. Go a little bit beyond sharp focus until the image starts to blur again, then reverse the rotation of the knob, just to make sure you've hit the exact focus point.

### Do You Wear Eyeglasses?

If you wear eyeglasses, you may be able to keep them on while you observe. In order to do this, your eyepiece must have enough "eye relief" to allow you to see the entire field of view with glasses on. You can try looking through the eyepiece first with your glasses on and then with them off, to see if the glasses restrict the view to only a portion of the full field. If the glasses do restrict the field of view, you may be able to observe with your glasses off by just refocusing the telescope to your unaided vision.

If your eyes are astigmatic, images will probably appear best with glasses on. This is because a telescope's focuser can accommodate for nearsightedness or farsightedness, but not astigmatism. If you have to wear your glasses while observing and cannot see the entire field of view, you may want to purchase additional eyepieces that have longer eye relief.

Short eye relief restricts the field of view for eyeglass wearers.

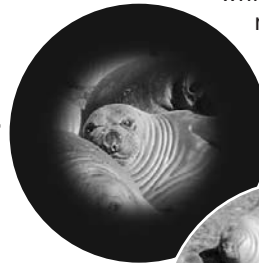

Long eye relief allows full field of view to be seen with or without eyeglasses.



### Operating the EZ Finder II reflex finder

The **EZ Finder II reflex finder (2)** (Figure 6) works by projecting a tiny red dot onto a lens mounted in the front of the unit. When you look through the EZ Finder II, the red dot will appear to float in space. The red dot is produced by a light-emitting diode (LED), not a laser beam, near the rear of the sight. A replaceable 3-volt lithium battery provides the power for the diode.

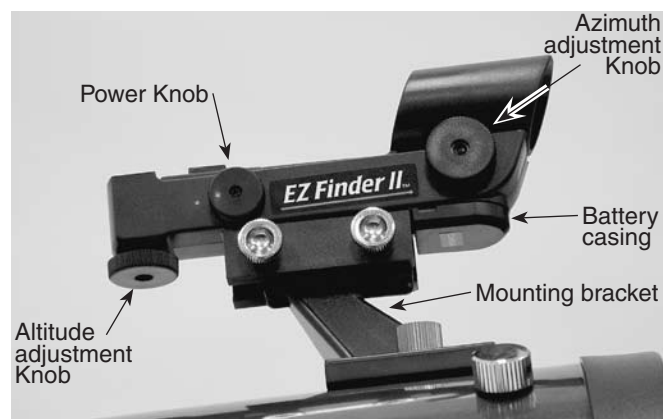

**Figure 6.** The EZ Finder II reflex sight.



To use the EZ Finder II, turn the power knob clockwise until you hear a “click” indicating that power has been turned on. With your eye positioned at a comfortable distance, look through the back of the reflex sight with both eyes open to see the red dot. The intensity of the dot can be adjusted by turning the power knob. For best results when stargazing, use the dimmest possible setting that allows you to see the dot without difficulty. Typically, a dim setting is used under dark skies and a bright setting is used under light-polluted skies or in daylight.

At the end of your observing session, be sure to turn the power knob counterclockwise until it clicks off. When the two white dots on the EZ Finder II’s rail and power knob are lined up, the EZ Finder II is turned off.

### Aligning the EZ Finder II

When the EZ Finder II is properly aligned with the telescope, an object that is centered on the EZ Finder II’s red dot should also appear in the center of the field of view of the telescope’s eyepiece. Alignment of the EZ Finder II is easiest during daylight, before observing at night. Aim the telescope at a distant object at least 1/4 mile away, such as a telephone pole or chimney and center it in the telescope’s eyepiece. Now, turn the EZ Finder II on and look through it. The object will appear in the field of view near the red dot.

**Note: Remember that the image in the eyepiece of the StarBlast will be upside-down (rotated 180°). This is normal for Newtonian reflector telescopes.**

Without moving the telescope, use the EZ Finder II’s azimuth (left/right) and altitude (up/down) adjustment knobs to position the red dot on the object in the eyepiece.

When the red dot is centered on the distant object, check to make sure that the object is still centered in the telescope’s field of view. If not, recenter it and adjust the EZ Finder II’s alignment again. When the object is centered in the eyepiece and on the red dot, the EZ Finder II is properly aligned with the telescope. Figure 7 shows how the view through the EZ Finder may look while you are aligning it.

Once aligned, EZ Finder II will usually hold its alignment even after being removed and remounted. Otherwise, only minimal realignment will be needed.



**Figure 7.**

The EZ Finder II superimposes a tiny red dot on the sky, showing right where the telescope is pointed.

### Replacing the EZ Finder II Battery

Replacement 3-volt lithium batteries for the EZ Finder II are available from many retail outlets. Remove the old battery by inserting a small flat-head screwdriver into the slot on the battery casing (Figure 6) and gently prying open the case. Then carefully pull back on the retaining clip and remove the old battery. Do not overbend the retaining clip. Slide the new battery under the battery lead with the positive (+) side facing down and replace the battery casing.

## Using your telescope

### Choosing an Observing Site

When selecting a location for observing, get as far away as possible from direct artificial light such as street lights, porch lights, and automobile headlights. The glare from these lights will greatly impair your dark-adapted night vision. Avoid viewing over rooftops and chimneys, as they often have warm air currents rising from them. Similarly, avoid observing from indoors through an open (or closed) window, because the temperature difference between the indoor and outdoor air will cause image blurring and distortion.

If at all possible, escape the light-polluted city sky and head for darker country skies. You’ll be amazed at how many more stars and deep-sky objects are visible in a dark sky!

### Light Pollution

Most of us live where city lights interfere with our view of the heavens. As our metropolitan areas have become more developed, the scourge of light pollution has spread, washing out many stars and nonstellar celestial objects from our sight. Faint deep sky objects become difficult or impossible to see through the murk of light pollution. Even bright nebulas like the Orion and Lagoon Nebulas lose much of their delicate detail. The Moon and planets are not affected; they require steady air more than dark skies, so they remain good targets for city-dwelling observers.

The International Dark-Sky Association is waging the fight against light pollution. The IDSA was founded in 1988 with the mission of educating the public about the adverse impact that light pollution has on the night sky and astronomy. Through educational and scientific means, the nonprofit IDA works to raise awareness about the problem and about measures that can be taken to solve it.

Do you need help dealing with local officials to control street or building lighting in your area? The IDA’s extensive support materials can show you how. Help preserve dark skies, join the IDA today! For information, write to IDA, 3225 N. First Ave., Tucson, AZ 85719-2103 or visit their website: [www.darksky.org](http://www.darksky.org).

The best way to avoid immediate problems with light pollution, however, is to take your telescope to where there are dark skies. You will be amazed at how many stars you can see when you get away from the city lights.

## “Seeing” and Transparency

Atmospheric conditions vary significantly from night to night. “Seeing” refers to the steadiness of the Earth’s atmosphere at a given time. In conditions of poor seeing, atmospheric turbulence causes objects viewed through the telescope to “boil”. If, when you look up at the sky with your naked eyes, the stars are twinkling noticeably, the seeing is bad and you will be limited to viewing with low powers (bad seeing affects images at high powers more severely). Planetary observing may also be poor.

In conditions of good seeing, star twinkling is minimal and images appear steady in the eyepiece. Seeing is best overhead, worst at the horizon. Also, seeing generally gets better after midnight, when much of the heat absorbed by the Earth during the day has radiated off into space.

Especially important for observing faint objects is good “transparency” - air free of moisture, smoke, and dust. All tend to scatter light, which reduces an object’s brightness. Transparency is judged by the magnitude of the faintest stars you can see with the unaided eye (6th magnitude or fainter is desirable).

If you cannot see stars of magnitude 3.5 or dimmer then conditions are poor. Magnitude is a measure of how bright a star is - the brighter a star is, the lower its magnitude will be. A good star to remember for this is Megrez (mag. 3.4), which is the star in the “Big Dipper” connecting the handle to the “dipper”. If you cannot see Megrez, then you have fog, haze, clouds, smog, or other conditions that are hindering your viewing. (See Figure 8)

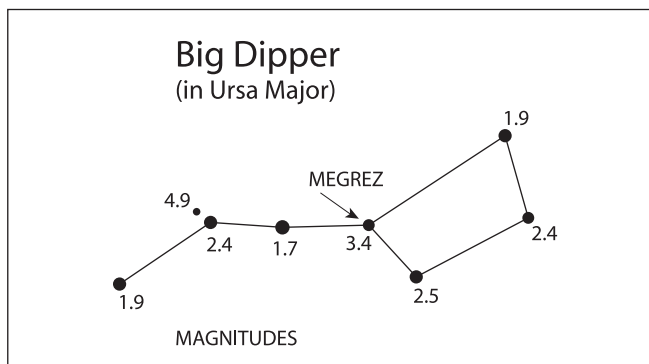

**Figure 8.** Megrez connects the Big Dipper’s handle to its “pan”. It is a good guide to how conditions are. If you can not see Megrez (a 3.4 mag star) then conditions are poor.

## Tracking Celestial Objects

The Earth is constantly rotating about its polar axis, completing one full rotation every 24 hours; this is what defines a “day”. We do not feel the Earth rotating, but we see it at night from the apparent movement of stars from east to west.

When you observe any astronomical object, you are watching a moving target. This means the telescope’s position must be continuously adjusted over time to keep an object in the field of view. This is easy to do with the StarBlast because

of its smooth motions on both axes. As the object moves off towards the edge of the field of view, just lightly nudge the telescope to re-center it.

Objects appear to move across the field of view faster at higher magnifications. This is because the field of view becomes narrower.

## Eyepiece Selection

By using eyepieces of different focal lengths, it is possible to attain many magnifications or powers with the StarBlast. Your telescope comes with two Kellner eyepieces (Figure 9): a 17mm, which gives a magnification of 26x, and a 6mm, which gives a magnification of 75x. Other eyepieces can be used to achieve higher or lower powers. It is quite common for an observer to own five or more eyepieces to access a wide range of magnifications.



**Figure 9.** The 17mm and 6mm Explorer II eyepieces.

To calculate the magnification of a telescope-eyepiece combination, simply divide the focal length of the telescope by the focal length of the eyepiece.

$$\text{Telescope Focal Length (mm)} \div \text{Eyepiece Focal Length(mm)} = \text{Magnification}$$

For example, the StarBlast, which has a focal length of 450mm, used in combination with the 17mm eyepiece, yields a magnification of

$$450\text{mm} \div 17\text{mm} = 26\text{x}$$

Whatever you choose to view, always start by inserting your lowest-power (longest focal length) eyepiece to locate and center the object. Low magnification yields a wide field of view, which shows a larger area of sky in the eyepiece. This makes finding and centering an object much easier. Trying to find and center objects with a high power (narrow field of view) eyepiece is like trying to find a needle in a haystack!

Once you’ve centered the object in the eyepiece, you can switch to a higher magnification (shorter focal length) eye-

piece, if you wish. This is recommended for small and bright objects, like planets and double stars. The Moon also takes higher magnifications well.

The best rule of thumb with eyepiece selection is to start with a low power, wide-field eyepiece, and then work your way up in magnification. If the object looks better, try an even higher magnification eyepiece. If the object looks worse, then back off the magnification a little by using a lower-power eyepiece.

### Magnification Limits

Every telescope has a useful magnification limit of about 2X per millimeter of aperture. This comes to 226X for the StarBlast. Some telescope manufacturers will use misleading claims of excess magnification, such as "See distant galaxies at 640X!". While such magnifications are technically possible, the actual image at that magnification would be an indistinct blur.

Moderate magnifications are what give the best views. It is better to view a small, but bright and detailed image than a dim, unclear, oversized image.

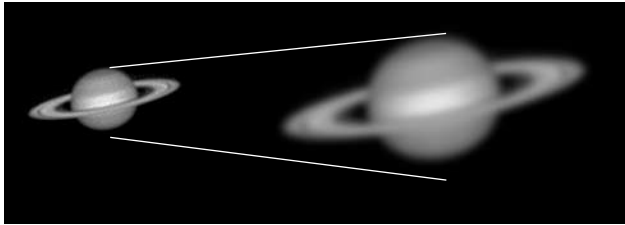

### What to Expect

So what will you see with your telescope? You should be able to see bands on Jupiter, the rings of Saturn, craters on the Moon, the waxing and waning of Venus, and many bright deep-sky objects. Do not expect to see color as you do in NASA photos, since those are taken with long-exposure cameras and have "false color" added. Our eyes are not sensitive enough to see color in deep-sky objects except in a few of the brightest ones.

Remember that you are seeing these objects using your own telescope with your own eyes! The object you see in your eyepiece is in real-time, and not some conveniently provided image from an expensive space probe. Each session with your telescope will be a learning experience. Each time you work with your telescope it will get easier to use, and stellar objects will become easier to find. Take it from us, there is big difference between looking at a well-made full-color NASA image of a deep-sky object in a lit room during the daytime, and seeing that same object in your telescope at night. One can merely be a pretty image someone gave to you. The other is an experience you will never forget!

### Objects to Observe

Now that you are all set up and ready to go, one critical decision must be made: what to look at?

#### The Moon

With its rocky surface, the Moon is one of the easiest and most interesting targets to view with your telescope. Lunar craters, maria, and even mountain ranges can all be clearly seen from a distance of 238,000 miles away! With its ever-changing phases, you'll get a new view of the Moon every night. The best time to observe our one and only natural satellite is during a partial phase, that is, when the Moon is NOT full. During partial phases, shadows are cast on the surface, which reveal more detail, especially right along the border between the dark and light portions of the disk (called the "terminator"). A full Moon is too bright and devoid of surface shadows to yield a pleasing view. Make sure to observe the Moon when it is well above the horizon to get the sharpest images.

Use an optional Moon filter to dim the Moon when it is very bright. It simply threads onto the bottom of the eyepieces (you must first remove the eyepiece from the focuser to attach a filter). You'll find that the Moon filter improves viewing comfort, and also helps to bring out subtle features on the lunar surface.

#### B. The Sun

You can change your nighttime telescope into a daytime Sun viewer by installing an optional full-aperture solar filter over the front opening of the StarBlast. The primary attraction is sunspots, which change shape, appearance, and location daily. Sunspots are directly related to magnetic activity in the Sun. Many observers like to make drawings of sunspots to monitor how the Sun is changing from day to day.

**Important Note: Do not look at the Sun with any optical instrument without a professionally made solar filter, or permanent eye damage could result. Do not use the EZ Finder when solar viewing either.**

#### C. The Planets

Planets, being in our own solar system and having their own orbits, do not stay at "fixed" locations like the stars do. So to find them you should refer to Sky Calendar at our website (telescope.com), or to charts published monthly in *Astronomy*, *Sky & Telescope*, or other astronomy magazines. Venus, Jupiter, and Saturn are the brightest objects in the sky after the Sun and the Moon. Your StarBlast is capable of showing you these planets in some detail. Other planets may be visible but will likely appear star-like. Because planets are quite small in apparent size, optional higher-power eyepieces are recommended and often needed for detailed observations. Not all the planets are generally visible at any one time.

**JUPITER:** The largest planet, Jupiter, is a great subject for observation. You can see the disk of the giant planet and watch the ever-changing positions of its four largest moons - Io, Callisto, Europa, and Ganymede.

**SATURN:** The ringed planet is a breathtaking sight when it is well positioned. The tilt angle of the rings varies over a period of many years; sometimes they are seen edge-on, while at other times they are broadside and look like giant "ears" on each side of Saturn's disk. A steady atmosphere (good seeing) is necessary for a good view. You will probably see a bright "star" close by, which is Saturn's brightest moon, Titan.



---

**VENUS:** At its brightest, Venus is the most luminous object in the sky, excluding the Sun and the Moon. It is so bright that sometimes it is visible to the naked eye during full daylight! Ironically, Venus appears as a thin crescent, not a full disk, when at its peak brightness. Because it is so close to the Sun, it never wanders too far from the morning or evening horizon. No surface markings can be seen on Venus, which is always shrouded in dense clouds.

#### **D. The Stars**

Stars will appear like twinkling points of light. Even powerful telescopes cannot magnify stars to appear as more than a point of light. You can, however, enjoy the different colors of the stars and locate many pretty double and multiple stars. The gorgeous two-color double star Albireo in Cygnus is a favorite. Defocusing a star slightly can help bring out its color.

#### **E. Deep-Sky Objects**

Under dark skies, you can observe a wealth of fascinating deep-sky objects, including gaseous nebulas, open and globular star clusters, and a variety of different types of galaxies. Most deep-sky objects are very faint, so it is important that you find an observing site well away from light pollution. Take plenty of time to let your eyes adjust to the darkness. Do not expect these subjects to appear like the photographs you see in books and magazines; most will look like dim gray smudges. Our eyes are not sensitive enough to see color in deep-sky objects except in a few of the brightest ones. But as you become more experienced and your observing skills get sharper, you will be able to ferret out more and more subtle details and structure.

To find deep sky objects in the sky, it is best to consult a star chart or Planisphere. These guides will help you locate the brightest and best deep-sky objects for viewing with your StarBlast .

You can also try low-power scanning of the Milky Way. Use the 17mm eyepiece and just cruise through the "star clouds" of our galaxy. You'll be amazed at the rich fields of stars and objects you'll see! The Milky Way is best observed on summer and winter evenings.

## **Care and Maintenance**

If you give your telescope reasonable care, it will last a lifetime. Store it in a clean, dry, dust-free place, safe from rapid temperature changes and humidity. Do not store the telescope outdoors, although storage in a garage or shed is OK. Small components like eyepiece and other accessories should be kept in a protective box or storage case. Keep the dust caps on the front of the scope and on the focuser when it is not in use.

The telescope requires very little mechanical maintenance. The optical tube is made of steel and has a smooth painted finish that is fairly scratch resistant. If a scratch does appear on the tube, it will not harm the telescope. Smudges on the tube can be wiped off with a soft cloth and a household cleaner such as Windex or Formula 409.

Refer to Appendix B for detailed instructions on how to clean the optics of the StarBlast.

## **Specifications**

Primary mirror: Parabolic, center marked

Primary mirror diameter: 113mm

Secondary mirror minor axis: 34.3mm

Mirror coatings: Aluminum with SiO<sub>2</sub> overcoat

Focal length: 450mm

Focal ratio: f/4.0

Focuser: Rack-and-pinion, accepts 1.25" eyepieces

Eyepieces: 17mm and 6mm Explorer II, 1.25"

Magnification: 26x (with 17mm), 75x (with 6mm)

Finder: EZ Finder II reflex sight

Mount: Altazimuth, wood base, eyepiece rack, integral carry handle

Weight: 13 lbs.

Tube Length: 18"

Tube Outer Diameter: 5.5"

## **Appendix A: Aligning the Mirrors**

Your telescope's optics were aligned at the factory, and should not need much adjustment unless the telescope is handled roughly. Accurate mirror alignment is important to ensure the peak performance of your telescope, so it should be checked regularly. Collimating (aligning the mirrors) is relatively easy to do and can be done in daylight.

To check collimation (mirror alignment), remove the eyepiece and look down the focuser (4) . You should see the secondary mirror (16) centered in the drawtube, as well as the reflection of the primary mirror (15) centered in the secondary mirror, and the reflection of the secondary mirror (and your eye) centered in the reflection of the primary mirror, as in Figure 10a. If anything is off-center, as in Figure 10b, proceed with the following collimation procedure.

### **The Collimation Cap and Mirror Center Mark**

Your StarBlast comes with a collimation cap (17). This is a simple cap that fits on the focuser like a dust cap, but has a hole in the center and a silver bottom. This helps center your eye so that collimating is easy to perform. Figures 10b, c, d and e assume you have the collimation cap in place.

In addition to the collimation cap, the primary mirror is marked with a ring with the hole exactly at the center of the primary mirror. This is of great help in collimating the primary mirror since you can center the dot of the collimation cap in the middle of the ring.

**Note: The center ring sticker need not ever be removed from the primary mirror. Because it lies directly in the shadow of the secondary mirror, its presence in no way**

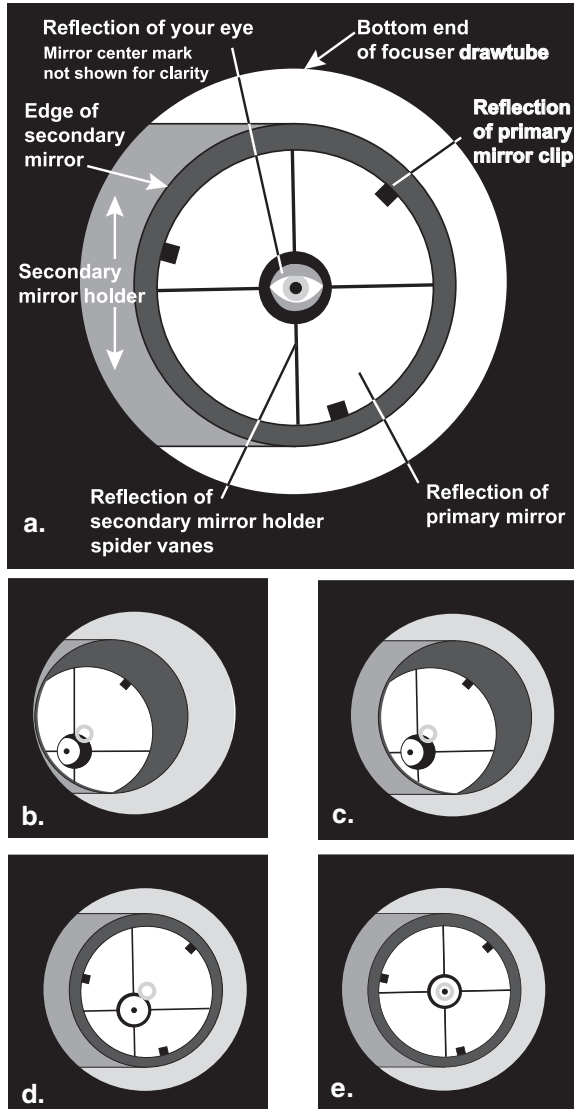

**Figure 10.** Collimating the optics. (a) When the mirrors are properly aligned, the view down the focuser drawtube should look like this. (b) With the collimation cap in place, if the optics are out of alignment, the view might look something like this. (c) Here, the secondary mirror is centered under the focuser, but it needs to be adjusted (tilted) so that the entire primary mirror is visible. (d) The secondary mirror is correctly aligned, but the primary mirror still needs adjustment. When the primary mirror is correctly aligned, the “dot” will be centered, as in (e).

**adversely affects the optical performance of the telescope or the image quality. That might seem counterintuitive, but it's true!**

### Aligning the Secondary Mirror

With the collimation cap in place, look through the hole in the cap at the secondary (diagonal) mirror. Ignore the reflections for the time being. The secondary mirror itself should be centered in the focuser drawtube, in the direction parallel to the

length of the telescope. If it isn't, as in Figure 10b, it must be adjusted. This adjustment will rarely, if ever need to be done.

It helps to adjust the secondary mirror in a brightly lit room with the telescope pointed towards a bright surface, such as white paper or wall. Also placing a piece of white paper in the telescope tube opposite the focuser (in other words, on the other side of the secondary mirror) will also be helpful in collimating the secondary mirror. Using a 2mm hex key, loosen the three small alignment set screws in the center hub of the 4-vaned spider several turns. Now hold the secondary mirror holder stationary (be careful not to touch the surface of the second-



**Figure 11.** To center the secondary mirror under the focuser, hold the secondary mirror holder in place with your fingers while adjusting the center screw with the Phillips head screwdriver. Do not touch the mirror's surface.

ary mirror), while turning the center screw with a Phillips head screwdriver (See Figure 11). Turning the screw clockwise will move the secondary mirror toward the front opening of the optical tube, while turning the screw counter-clockwise will move the secondary mirror toward the primary mirror.

**Note:** When making these adjustments, be careful not to stress the spider vanes or they may bend.

When the secondary mirror is centered in the focuser drawtube, rotate the secondary mirror holder until the reflection of the primary mirror is as centered in the secondary mirror as possible. It may not be perfectly centered, but that is OK. Now tighten the three small alignment screws equally to secure the secondary mirror in that position.

If the entire primary mirror reflection is not visible in the secondary mirror, as in Figure 10c; you will need to adjust the tilt of the second-

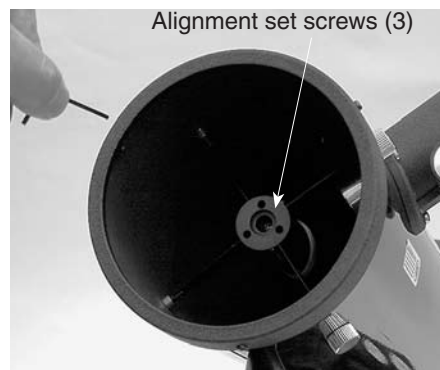

**Figure 12.** Adjust the tilt of the secondary mirror by loosening or tightening the three alignment set screws with a 2mm hex key.

ary mirror. This is done by alternately loosening one of the three alignment set screws while tightening the other two, as depicted in Figure 12. The goal is to center the primary mirror reflection in the secondary mirror, as in figure 10d. Don't worry that the reflection of the secondary mirror (the smallest circle, with the collimation cap "dot" in the center) is off-center. You will fix that in the next step.

### Aligning the Primary Mirror

The final adjustment is made to the primary mirror. It will need adjustment if, as in Figure 10d, the secondary mirror is centered under the focuser and the reflection of the primary mirror is centered in the secondary mirror, but the small reflection of the secondary mirror (with the "dot" of the collimation cap) is off-center.

The tilt of the primary mirror is adjusted with three spring-

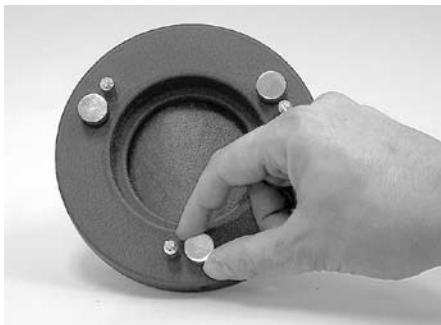

**Figure 13.** The three thin thumbscrews that lock the primary mirror in place must first be loosened before any adjustments can be made.

loaded collimation thumbscrews on the back end of the optical tube (bottom of the primary mirror cell); these are the wide thumbscrews. The other three thin thumbscrews lock the mirror's position in place; these thin thumbscrews must be loosened before any collimation adjustments can be made to the primary mirror.

To start, turn the thin thumbscrews that lock the primary mirror in place a few turns each. (Figure 13)

Now, try tightening or loosening one of the wide collimation thumbscrews with your fingers (Figure 14). Look into the focuser and see if the secondary mirror reflection has moved closer to the center of the primary. You can tell this easily with the collimation cap and mirror center mark by simply watching to see if the "dot" of the collimation cap is moving closer or further away from being centered in the "ring" of the primary mirror mark. When you



**Figure 14.** The tilt of the primary mirror is adjusted by turning one or more of the three wide collimation thumbscrews.

have that dot centered as much as is possible in the ring, your primary mirror is collimated. The view through the collimation cap should resemble Figure 10e. Re-tighten the locking thumbscrews.

A simple star test will tell you whether the optics are accurately collimated.

### Star-Testing the Telescope

When it is dark, point the telescope at a bright star and accurately center it in the eyepiece's field of view. Slowly de-focus the

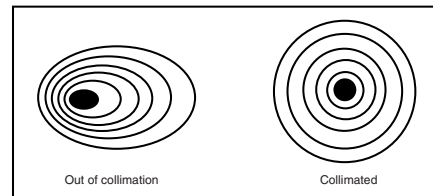

**Figure 15.** A star test will determine if the telescope's optics are properly collimated. An unfocused view of a bright star through

the eyepiece should appear as illustrated on the right if optics are perfectly collimated. If the circle is unsymmetrical, as illustrated on the left, the scope needs collimation.

image with the focusing knob. If the telescope is correctly collimated, the expanding disk should be a perfect circle (Figure 15). If the image is unsymmetrical, the scope is out of collimation. The dark shadow cast by the secondary mirror should appear in the very center of the out-of-focus circle, like the hole in a donut. If the "hole" appears off-center, the telescope is out of collimation.

If you try the star test and the bright star you have selected is not accurately centered in the eyepiece, the optics will always appear out of collimation, even though they may be perfectly aligned. It is critical to keep the star centered, so over time you will need to make slight corrections to the telescope's position in order to account for the sky's apparent motion.

## Appendix B: Cleaning the Optics

### Cleaning Lenses

Any quality optical lens cleaning tissue and optical lens cleaning fluid specifically designed for multi-coated optics can be used to clean the exposed lenses of your eyepieces. Never use regular glass cleaner or cleaning fluid designed for eyeglasses

Before cleaning with fluid and tissue, blow any loose particles off the lens with a blower bulb or compressed air. Then apply some cleaning fluid to a tissue, never directly on the optics. Wipe the lens gently in a circular motion, then remove any excess fluid with a fresh lens tissue. Oily fingerprints and smudges may be removed using this method. Use caution; rubbing too hard may scratch the lens. Never reuse tissues.

### Cleaning Mirrors

You should not have to clean the telescope's mirror very often; normally once every year or so. Covering the telescope with

---

the dust cap when it is not in use will help prevent dust from accumulating on the mirrors. Improper cleaning can scratch mirror coatings, so the fewer times you have to clean the mirrors, the better. Small specks of dust or flecks of paint have virtually no effect on the visual performance of the telescope.

The large primary mirror and the elliptical secondary mirror of your telescope are front-surface aluminized and over coated with hard silicon dioxide, which prevents the aluminum from oxidizing. These coatings normally last through many years of use before requiring re-coating, which is easily done.

To clean the secondary mirror, it must be removed from the telescope. Do this by holding the secondary mirror holder stationary with your fingers (don't touch the mirror itself) while unthreading the Phillips head screw in the center hub of the 4-vaned spider. Completely unthread the screw from the holder, and the holder will come loose in your fingers. Be careful not to lose the spring on the Phillips head screw.

Handle the mirror and its holder carefully. You do not need to remove the secondary mirror from its holder for cleaning. Follow the same procedure described below for cleaning the primary mirror.

To clean the primary mirror, carefully remove the mirror cell from the telescope. To do this, you must remove the three

screws that connect the mirror cell to the steel tube. These screws are located on the outer edge of the mirror cell.

Now, remove the three mirror clips that secure the mirror in its cell; use a Phillips head screwdriver to unthread the mirror clip anchor screws. Next, hold the mirror by its edge, and remove it from the mirror cell. Be careful not to touch the aluminized surface of the mirror with your fingers. Set the mirror on a clean, soft towel. Fill a clean sink, free of abrasive cleanser, with room-temperature water, a few drops of liquid dishwashing detergent, and if possible, a cap-full of rubbing alcohol. Submerge the mirror (aluminized face up) in the water and let it soak for several minutes (or hours if it is a very dirty mirror). Wipe the mirror underwater with clean cotton balls, using extremely light pressure and stroking in straight lines across the surface. Use one ball for each wipe across the mirror. Then rinse the mirror under a stream of lukewarm water. Any particles on the surface can be swabbed gently with a series of clean cotton balls, each used just one time. Dry the mirror in a stream of air (a "blower bulb" works great), or remove any stray drops of water with the corner of a paper towel. Dry the bottom and the edges with a towel (not the mirror surface!). Leave the entire assembly in a warm area until it is completely dry before reassembling the telescope.

## **One-Year Limited Warranty**

This Orion StarBlast is warranted against defects in materials or workmanship for a period of one year from the date of purchase. This warranty is for the benefit of the original retail purchaser only. During this warranty period Orion Telescopes & Binoculars will repair or replace, at Orion's option, any warranted instrument that proves to be defective, provided it is returned postage paid to: Orion Warranty Repair, 89 Hangar Way, Watsonville, CA 95076. If the product is not registered, proof of purchase (such as a copy of the original invoice) is required.

This warranty does not apply if, in Orion's judgment, the instrument has been abused, mishandled, or modified, nor does it apply to normal wear and tear. This warranty gives you specific legal rights, and you may also have other rights, which vary from state to state. For further warranty service information, contact: Customer Service Department, Orion Telescopes & Binoculars, 89 Hangar Way, Watsonville, CA 95076; (800)-676-1343.

## **Orion Telescopes & Binoculars**

**89 Hangar Way, Watsonville, CA 95076**

**Customer Support Help Line (800)-676-1343 • Day or Evening**